

Circular surface mounted luminaires with excellent lateral distribution

The Ovix features an indirect light source and clear, fire-retardant polycarbonate cover making it a highly efficient ultra low-glare luminaire. The excellent lateral light distribution allows for wider spacings than 38 W 2D or existing LED luminaires.

Available in 10 W, 17 W and 24 W.

Applications : Corridors, General Circulation Areas, Staircases, Bedrooms, Toilet areas.

- Low profile unobtrusive design
- Wipe clean surface, no dust traps
- Excellent lateral light distribution - suitable for stairwells
- Tool free access (option to lock cover using locking screw supplied)
- Indirect light source, extremely low glare and high visual comfort
- SmartScan wireless technology removes the need for control cabling. Ideal for retro-fit

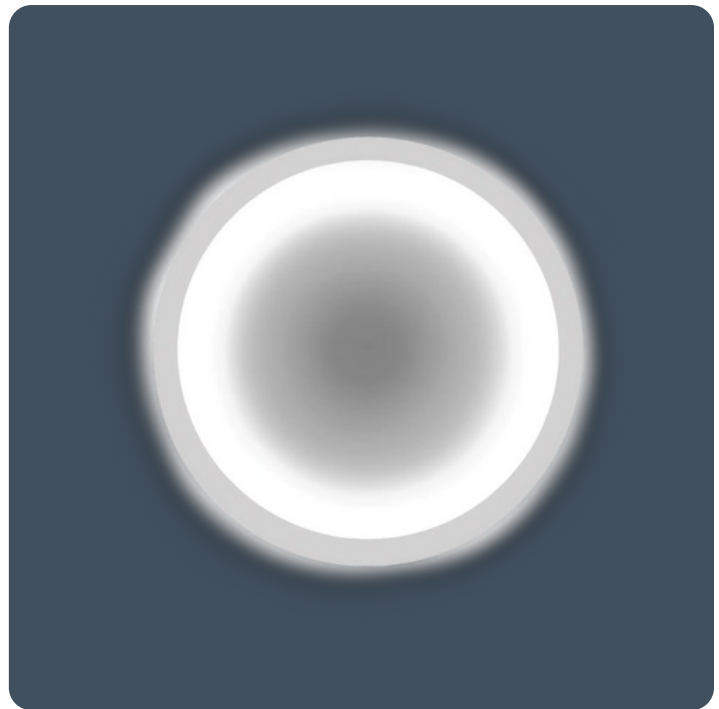

IP40

IK09

Up to 142.4 LL/CW

Specification

Mounting	Surface	IP rating	IP40
Impact rating	IK09	Max presence detection height	8 m

Lighting

Optic	Clear cover	Lumen output	1,665 lm - 3,685 lm
Efficacy	Up to 142.4 LL/CW		

Emergency data

Emergency lumen output	340 lm	Emergency type	Maintained
Emergency duration	3 hours	Battery specification	Nickel Metal Hydride (NiMH)

Power

LED power	10 W - 24 W	Circuit power	13 W - 27 W
-----------	-------------	---------------	-------------

LED characteristics

CRI	80+	Colour temperature	4000 K
Rated life (hours)	90 K - L80/B10		

Compliance

UKCA	Yes	CE	Yes
Energy efficiency class	This product contains a light source of energy efficiency class A		

Dimensions

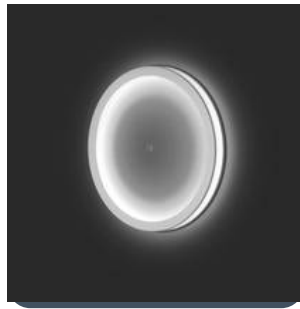
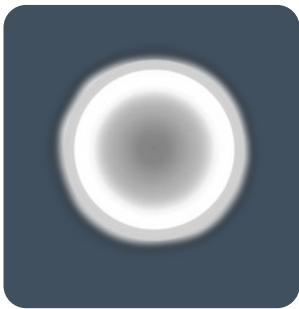
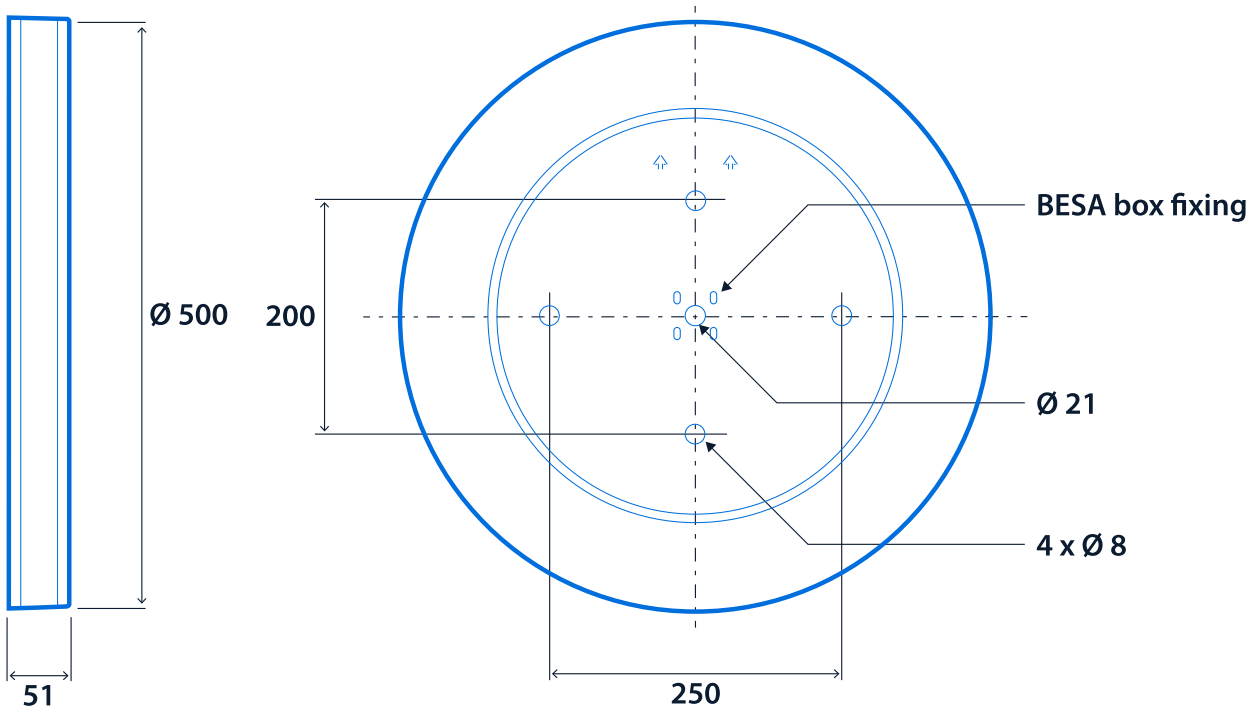

Click or scan here
View Ovix variants using our
online filtering tool



Information is correct as of 29 Dec 2024, however must not be interpreted as a guarantee of individual product performance and/or characteristics. We reserve the right to alter specifications and designs without prior notice.